

GAZELLE®

GM4518 Polisher User Manual



EN

Read through carefully and understand these instructions before use.

General power tool safety warnings



WARNING Read all safety warnings, instructions, illustrations and specifications provided with this power tool. Failure to follow all instructions listed below may result in electric shock, fire and/or serious injury.

Save all warnings and instructions for future reference.

The term "power tool" in the warnings refers to your mains-operated (corded) power tool or battery-operated (cordless) power tool.

1) Work area safety

- a) **Keep work area clean and well lit.** Cluttered or dark areas invite accidents.
- b) **Do not operate power tools in explosive atmospheres, such as in the presence of flammable liquids, gases or dust.** Power tools create sparks which may ignite the dust or fumes.
- c) **Keep children and bystanders away while operating a power tool.** Distractions can cause you to lose control.

2) Electrical Safety

- a) **Power tool plugs must match the outlet. Never modify the plug in any way. Do not use any adapter plugs with earthed (grounded) power tools.** Unmodified plugs and matching outlets will reduce risk of electric shock.
- b) **Avoid body contact with earthed or grounded surfaces, such as pipes, radiators, ranges and refrigerators.** There is an increased risk of electric shock if your body is earthed or grounded.
- c) **Do not expose power tools to rain or wet conditions.** Water entering a power tool will increase the risk of electric shock.
- d) **Do not abuse the cord. Never use the cord for carrying, pulling or unplugging the power tool. Keep cord away from heat, oil, sharp edges or moving parts.** Damaged or entangled cords increase the risk of electric shock.
- e) **When operating a power tool outdoors, use an extension cord suitable for outdoor use.** Use of a cord suitable for outdoor use reduces the risk of electric shock.
- f) **If operating a power tool in a damp location is unavoidable, use a residual current device (RCD) protected supply.** Use of an RCD reduces the risk of electric shock.

3) Personal safety

- a) **Stay alert, watch what you are doing and use common sense when operating a power tool. Do not use a power tool while you are tired or under**

the influence of drugs, alcohol or medication. A moment of inattention while operating power tools may result in serious personal injury.

- b) **Use personal protective equipment. Always wear eye protection.** Protective equipment such as a dust mask, non-skid safety shoes, hard hat or hearing protection used for appropriate conditions will reduce personal injuries.
- c) **Prevent unintentional starting. Ensure the switch is in the off-position before connecting to power source and/or battery pack, picking up or carrying the tool.** Carrying power tools with your finger on the switch or energising power tools that have the switch on invites accidents.
- d) **Remove any adjusting key or wrench before turning the power tool on.** A wrench or a key left attached to a rotating part of the power tool may result in personal injury.
- e) **Do not overreach. Keep proper footing and balance at all times.** This enables better control of the power tool in unexpected situations.
- f) **Dress properly. Do not wear loose clothing or jewellery. Keep your hair and clothing away from moving parts.** Loose clothes, jewellery or long hair can be caught in moving parts.
- g) **If devices are provided for the connection of dust extraction and collection facilities, ensure these are connected and properly used.** Use of dust collection can reduce dust-related hazards.
- h) **Do not let familiarity gained from frequent use of tools allow you to become complacent and ignore tool safety principles.** A careless action can cause severe injury within a fraction of a second.

4) Power Tool Use and Care

- a) **Do not force the power tool. Use the correct power tool for your application.** The correct power tool will do the job better and safer at the rate for which it was designed.
- b) **Do not use the power tool if the switch does not turn it on and off.** Any power tool that cannot be controlled with the switch is dangerous and must be repaired.
- c) **Disconnect the plug from the power source and/or remove the battery pack, if detachable, from the power tool before making any adjustments, changing accessories, or storing power tools.** Such preventive safety measures reduce the risk of starting the power tool accidentally.
- d) **Store idle power tools out of the reach of children and do not allow persons unfamiliar with the power tool or these instructions to operate the power tool.** Power tools are dangerous in the hands of untrained users.
- e) **Maintain power tools and accessories. Check**

for misalignment or binding of moving parts, breakage of parts and any other condition that may affect the power tool's operation. If damaged, have the power tool repaired before use. Many accidents are caused by poorly maintained power tools.

- f) **Keep cutting tools sharp and clean.** Properly maintained cutting tools with sharp cutting edges are less likely to bind and are easier to control.
 - g) **Use the power tool, accessories and tool bits etc. in accordance with these instructions, taking into account the working conditions and the work to be performed.** Use of the power tool for operations different from those intended could result in a hazardous situation.
 - h) **Keep handles and grasping surfaces dry, clean and free from oil and grease.** Slippery handles and grasping surfaces do not allow for safe handling and control of the tool in unexpected situations.
- 5) **Service**
- a) **Have your power tool serviced by a qualified repair person using only identical replacement parts.** This will ensure that the safety of the power tool is maintained.

Safety instructions for all operations

Safety warnings common for polishing operations:

- a) **This power tool is intended to function as a polisher. Read all safety warnings, instructions, illustrations and specifications provided with this power tool.** Failure to follow all instructions listed below may result in electric shock, fire and/or serious injury.
- b) **Operations such as grinding, sanding, wire brushing, hole cutting or cutting-off are not to be performed with this power tool.** Operations for which the power tool was not designed may create a hazard and cause personal injury.
- c) **Do not convert this power tool to operate in a way which is not specifically designed and specified by the tool manufacturer.** Such a conversion may result in a loss of control and cause serious personal injury.
- d) **Do not use accessories which are not specifically designed and specified by the tool manufacturer.** Just because the accessory can be attached to your power tool, it does not assure safe operation.
- e) **The rated speed of the accessory must be at least equal to the maximum speed marked on the power tool.** Accessories running faster than their rated speed can break and fly apart.
- f) **The outside diameter and the thickness of your accessory must be within the capacity rating of your power tool.** Incorrectly sized accessories cannot be adequately guarded or controlled.
- g) **The dimensions of the accessory mounting must fit the dimensions of the mounting hardware of the power tool.** Accessories that do not match the mounting hardware of the power tool will run out of balance, vibrate excessively and may cause loss of control.
- h) **Do not use a damaged accessory. Before each use inspect the accessory such as abrasive wheels for chips and cracks, backing pad for cracks, tear or excess wear, wire brush for loose or cracked wires. If power tool or accessory is dropped, inspect for damage or install an undamaged accessory. After inspecting and installing an accessory, position yourself and bystanders away from the plane of the rotating accessory and run the power tool at maximum no-load speed for one minute. Damaged accessories will normally break apart during this test time.**
- i) **Wear personal protective equipment. Depending on application, use face shield, safety goggles or safety glasses. As appropriate, wear dust mask, hearing protectors, gloves and workshop apron capable of stopping small abrasive or workpiece fragments. The eye protection must be capable of stopping flying debris generated by various applications. The dust mask or respirator must be capable of filtering particles generated by the particular application. Prolonged exposure to high intensity noise may cause hearing loss.**
- j) **Keep bystanders a safe distance away from work area. Anyone entering the work area must wear personal protective equipment. Fragments of workpiece or of a broken accessory may fly away and cause injury beyond immediate area of operation.**
- k) **Position the cord clear of the spinning accessory. If you lose control, the cord may be cut or snagged and your hand or arm may be pulled into the spinning accessory.**
- l) **Never lay the power tool down until the accessory has come to a complete stop. The spinning accessory may grab the surface and pull the power tool out of your control.**
- m) **Do not run the power tool while carrying it at your side. Accidental contact with the spinning accessory could snag your clothing, pulling the accessory into your body.**
- n) **Regularly clean the power tool's air vents. The motor's fan will draw the dust inside the housing and excessive accumulation of powdered metal may cause electrical hazards.**
- o) **Do not operate the power tool near flammable materials. Sparks could ignite these materials.**
- p) **Do not use accessories that require liquid**

coolants. *Using water or other liquid coolants may result in electrocution or shock.*

Further safety instructions for all operations

Kickback and related warnings:

Kickback is a sudden reaction to a pinched or snagged rotating wheel, backing pad, brush or any other accessory. Pinching or snagging causes rapid stalling of the rotating accessory which in turn causes the uncontrolled power tool to be forced in the direction opposite of the accessory's rotation at the point of the binding.

For example, if an abrasive wheel is snagged or pinched by the workpiece, the edge of the wheel that is entering into the pinch point can dig into the surface of the material causing the wheel to climb out or kick out. The wheel may either jump toward or away from the operator, depending on direction of the wheel's movement at the point of pinching. Abrasive wheels may also break under these conditions. Kickback is the result of power tool misuse and/or incorrect operating procedures or conditions and can be avoided by taking proper precautions as given below.

- a) **Maintain a firm grip with both hands on the power tool and position your body and arms to allow you to resist kickback forces. Always use auxiliary handle, if provided, for maximum control over kickback or torque reaction during start-up.** *The operator can control torque reactions or kickback forces, if proper precautions are taken.*
- b) **Never place your hand near the rotating accessory.** *Accessory may kickback over your hand.*
- c) **Do not position your body in the area where power tool will move if kickback occurs.** *Kickback will propel the tool in direction opposite to the wheel's movement at the point of snagging.*
- d) **Use special care when working corners, sharp edges, etc. Avoid bouncing and snagging the accessory.** *Corners, sharp edges or bouncing have a tendency to snag the rotating accessory and cause loss of control or kickback.*
- e) **Do not attach a saw chain woodcarving blade, segmented diamond wheel with a peripheral gap greater than 10 mm or toothed saw blade.** *Such blades create frequent kickback and loss of control.*

Additional safety instructions for polishing operations

Safety warnings specific for polishing operations:

- a) **Do not allow any loose portion of the polishing bonnet or its attachment strings to spin freely. Tuck away or trim any loose attachment strings.** *Loose and spinning attachment strings can entangle your fingers or snag on the workpiece.*

UK power plug warnings:

Your product is fitted with an BS 1363-1 approved electric plug with internal fuse approved to BS 1362. If the plug is not suitable for your socket, it should be removed and an appropriate plug should be fitted in its place by an authorized customer service agent. The replacement plug should have the same fuse rating as the original plug.

The severed plug must be disposed of to avoid a possible shock hazard and should never be inserted into a mains socket elsewhere.

Symbol



WARNING



To reduce the risk of injury, user must read instruction manual



Always Wear eye protection



Always operate with two hands



Class II tool

Technical Data

This product is suitable for polishing wood surface, painted wooden furniture surface, synthetic resin and hard rubber products, painted metal surface polishing.

The performance and specifications of this product are shown in the table below:

| Model | | GM4518 |
|-------------------|------|----------|
| Rated Power Input | W | 1400 |
| Rated Speed | /min | 690-3800 |
| Wheel Size | mm | Ø180 |
| Net Weight | kg | 3.4 |

※Due to the continuing program of research and development, the specifications herein are subject to change without prior notice.

INSTRUCTIONS FOR OPERATION

● Installing or Removing the Wool Disc

To install the wool disc, first remove all dirt and foreign matter from the pad. Then fix the spindle by pushing the shaft lock and tighten the pad on the spindle. Install the wool disc onto the pad.

When removing the wool disc, pull it from the pad, then fix the spindle by pushing the spindle lock, and loosen the pad.

CAUTION:

Always be sure that the tool is switched off and unplugged before installing or removing the polishing sponge.

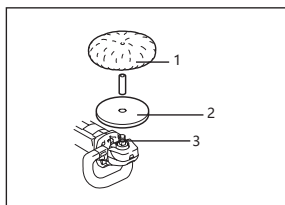

1. Wool Disc
2. Pad
3. Spindle

● Switch Operation

To start the tool, simply pull the switch button. Release the button to stop. For continuous operation, pull the button and then push in the lock button. To stop the tool from the locked position, pull the button fully and then release it.

CAUTION:

Before plugging in the tool, always check to see that the switch trigger actuates properly and returns to the "OFF" position when released.

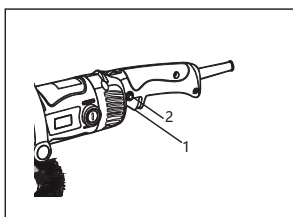

- 1.Lock Button
- 2.Switch Button

● Speed Adjusting

In order to meet different needs, the tool speed can be changed between 690 rpm and 3800 rpm by turning the speed control dial to a given number setting from 1 to 6. Higher speed is obtained when the dial is turned in the direction of number 6. And lower speed is obtained when it is turned in the direction of number 1.

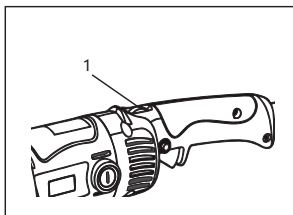

- 1.Constant Speed and Power Controller

CAUTION:

Refer to the table for the relationship between the number settings on the controller /dial and the approximate rotating speed. (Note: The data in the table is for reference only due to the influence of relevant uncertain factors).

| Number | Speed (.../min) |
|--------|-----------------|
| 1 | 690 |
| 2 | 1090 |
| 3 | 1800 |
| 4 | 2580 |
| 5 | 3160 |
| 6 | 3800 |

CAUTION:

The constant speed and power controller can be turned only as far as 1 and back to 6. Do not force it past 1 or 6, or the speed adjusting function may no longer work.

• **Polishing Operation**

Please adjust the speed to a lower speed when used the machine as a polisher.

CAUTION:

Always wear goggles and mask during operation.

1) When using the tool for polishing, do not force the tool on the surface of the workpiece to be polished. Sometimes the weight of the tool applies adequate pressure. Forcing and excessive pressure will result in poor performance and dangerous. At the same time, it will also lead to tool overload and motor burning.

2) Sanding disc, polishing oil or wax oil should be selected in accordance with the material and desired surface finish. Maximum polishing effect will be attained by following method:

- Using a fine-grain abrasive disc for preliminary polishing.
- Polishing with a polishing disc using polishing oil or wax. Apply a small quantity of oil or wax on the material surface before polishing.

CAUTION:

When using the tool for polishing, do not force the tool on the surface of the workpiece to be polished. Sometimes the weight of the tool applies adequate pressure. Forcing and excessive pressure will result in poor performance and dangerous. At the same time, it will also lead to tool overload and motor burning. Apply polishing oil or wax oil on the workpiece in accordance with the material and desired surface finish before polishing.

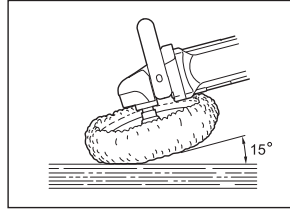

MAINTENANCE AND CARE

CAUTION:

Always be sure that the tool is switched off and unplugged before attempting to perform inspection or maintenance.

• **Clean the air vents**

The air inlet and air outlet of the tool should be cleaned regularly or at any time when it is blocked.

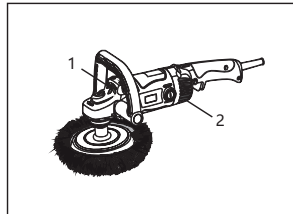

1. Air Outlet
2. Air Inlet

• **Check the mounting screws**

Should always check whether mounting screw fastening safely. If found loose screws, shall be immediately to tighten, so as to avoid an accident.

• **After Use**

Do not put down the tool immediately after the tool is turned off. Wait until the tool completely stops before putting it down. This can not only avoid accidents, but also reduce a large amount of dust and fine debris being sucked into the tool.

• **Check the Carbon Brushes**

Remove and check the carbon brushes regularly. Replace when they wear down to the limit mark. Keep the carbon brushes clean and free to slip in the holders. Both carbon brushes should be replaced at the same time.

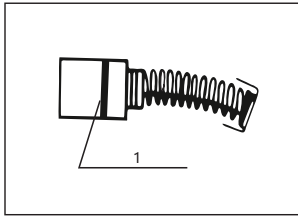

1.Limit Mark

• Replace the Carbon Brushes

Use a screwdriver to remove the brush holder caps, take out the worn carbon brushes, insert the new ones and secure the brush holder caps.

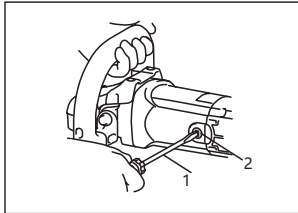

1.Brush Holder
Cap
2.Screwdriver

• Maintenance of the Motor

The motor unit winding is the very "heart" of the power tool. Exercise due care to ensure the winding does not become damaged and /or wet with oil or water.

※If the replacement of the supply cord is necessary, this has to be done by the manufacturer or his agent in order to avoid a safety hazard.

EXPLANATION OF GENERAL VIEW

| | | | |
|----|---|-----|---|
| 1 | Abrasive Disc | 32 | Baffle Plate |
| 2 | Gear Housing Cover | 33 | Cross Recessed Pan Head Tapping Screw ST5×63 |
| 3 | Cross Recessed Small Pan Head Screw M5×14(With Spring Washer) | 34 | Stator |
| 4 | Paper Washer | 35 | Insulation Washer |
| 5 | Big Dust Washer 27×20 | 36 | Bearing 608-2RS-DC03 |
| 6 | Ball Bearing 6202DD-DC01 | 37 | Bearing Rubber Sleeve (22×25×10.5) |
| 7 | Output Bearing Retainer | 39 | Capacitor 0.22μF (Short) |
| 8 | Cross Recessed Small Pan Head Screw M4×10(With Spring Washer) | 42 | Cross Recessed Pan Head Tapping Screw ST3.5×9 |
| 9 | Bevel Gear Wheel | 43 | Motor Housing |
| 10 | Flat Key 3×3×10 | 44 | Magnet Ring Assembly |
| 11 | Drive Spindle | 45 | Circlip For Shaft 8 |
| 12 | Needle Bearing | 46 | Retaining Sleeve |
| 14 | Small Waser A10 | 47 | Spring(2.15×0.35×10) |
| 15 | Socket Head Cap Screw M10×20 | 49 | Cross Recessed Pan Washer Head Tapping Screw ST4.2×15 |
| 16 | Auxiliary Handle | 50 | Cross Recessed Pan Head Tapping Screw ST4.2×17 |
| 17 | Gear Housing | 51 | Strain Relief |
| 18 | Cross Recessed Small Pan Head Screw M4×10(With Spring Washer) | 52 | Cord |
| 21 | Cross Recessed Pan Head Tapping Screw ST4.8×25 | 53 | Cord Guard |
| 22 | Ball Bearing 6200VV | 54 | Terminal Block |
| 23 | Big Damping Washer (30×33×4) | 861 | Hex Wrench (8mm) |
| 24 | Small Dust Washer 22×14 | 862 | Wool Polishing Wheel (Self-Adhesive) |
| 25 | Bearing Cover | T1 | Left And Right Handle |
| 27 | Armature | T2 | Switch Assembly |
| 29 | Brush Holder Assembly | T2 | Governor Switch Assembly (110V 60Hz) |
| 30 | Carbon Brush | T3 | Gear Housing Assembly |
| 31 | Brush Holder Cap | | |

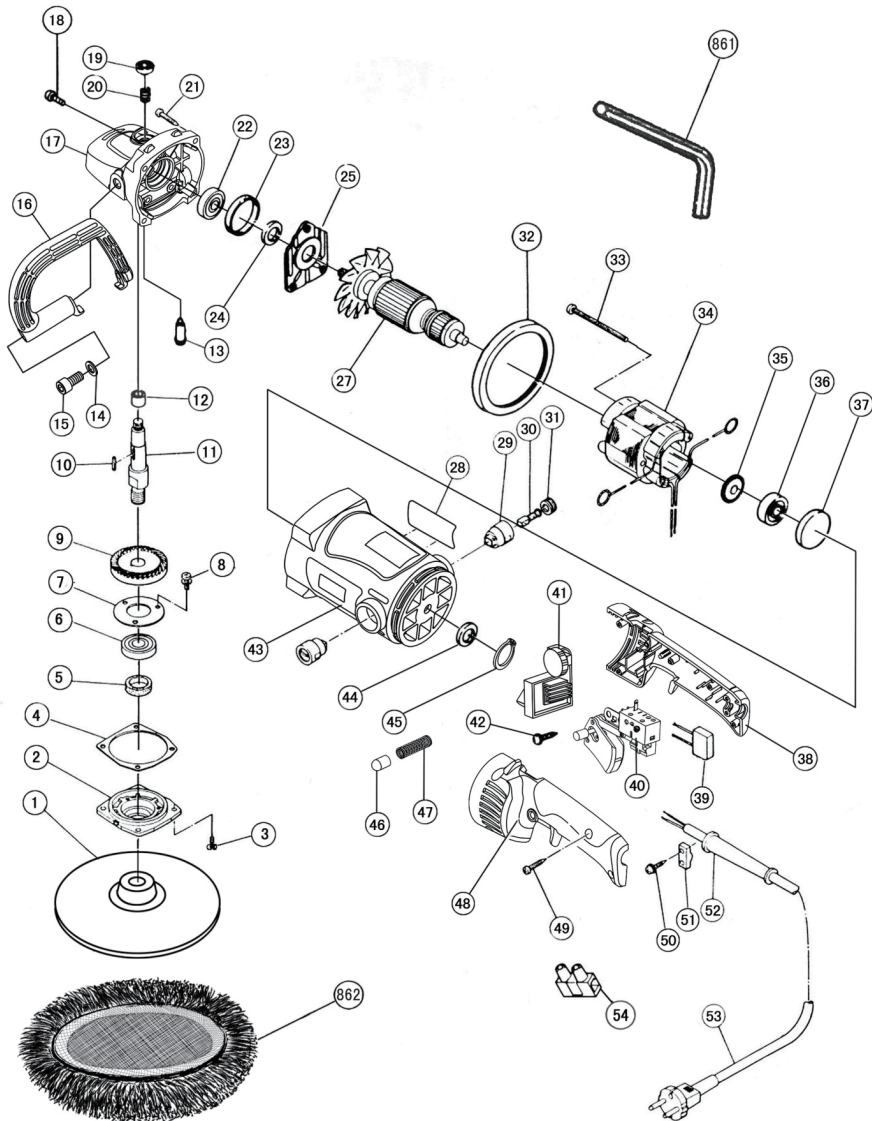

INNOVATION
PERFORMANCE
SAFETY
CONFIDENCE
GAZELLE

GAZELLE

sales@gazelleindustrial.com | www.gazelleindustrial.com