

GAZELLE®

GC2038 Cordless Brushless Angle Grinder User Manual



• Pictures of battery packs with different configurations vary in the illustration.

EN

Read through carefully and understand these instructions before use.

GENERAL POWER TOOL SAFETY

WARNINGS



WARNING Read all safety warnings, instructions, illustrations and specifications provided with this power tool.

Failure to follow all instructions listed below may result in electric shock, fire and/or serious personal injury.

Save all warnings and instructions for future reference.

The term "power tool" in the warnings refers to your mains-operated (corded) power tool or battery-operated (cordless) power tool.

1) Work Area Safety

- a) **Keep work area clean and well lit.** *Cluttered or dark areas invite accidents.*
- b) **Do not operate power tools in explosive atmospheres, such as in the presence of flammable liquids, gases or dust.** *Power tools create sparks which may ignite the dust or fumes.*
- c) **Keep children and bystanders away while operating a power tool.** *Distractions can cause you to lose control.*

2) Electrical Safety

- a) **Power tool plugs must match the outlet. Never modify the plug in anyway. Do not use any adapter plugs with earthed (grounded) power tools.** *Unmodified plugs and matching outlets will reduce risk of electric shock.*
- b) **Avoid body contact with earthed or grounded surfaces, such as pipes, radiators, ranges and refrigerators.** *There is an increased risk of electric shock if your body is earthed or grounded.*
- c) **Do not expose power tools to rain or wet conditions.** *Water entering a power tool will increase the risk of electric shock.*
- d) **Do not abuse the cord. Never use the cord for carrying, pulling or unplugging the power tool. Keep cord away from heat, oil, sharp edges or moving parts.** *Damaged or entangled cords increase the risk of electric shock.*
- e) **When operating a power tool outdoors, use an extension cord suitable for outdoor use.** *Use of a cord suitable for outdoor use reduces the risk of electric shock.*
- f) **If operating a power in a damp location is unavoidable, use a residual current device (RCD) protected supply.** *Use of an RCD reduces the risk of electric shock.*

3) Personal Safety

- a) **Stay alert, watch what you are doing and use common sense when operating a power tool. Do not use a power tool while you are tired or under the influence of drugs, alcohol, or medication. A**

moment of inattention while operating power tools may result in serious personal injury.

- b) **Use personal protective equipment. Always wear eye protection.** *Protective equipment such as dust mask, non-skid safety shoes, hard hat, or hearing protection used for appropriate conditions will reduce personal injuries.*
 - c) **Prevent unintentional starting. Ensure the switch is in the off-position before connecting to power source and /or battery pack, picking up or carrying the tool.** *Carrying power tools with your finger on the switch or energising power tools that have the switch on invites accidents.*
 - d) **Remove any adjusting key or wrench before turning the tool on.** *A wrench or a key left attached to a rotating part of the power tool may result in personal injury.*
 - e) **Do not overreach. Keep proper footing and balance at all times.** *This enables better control of the power tool in unexpected situations.*
 - f) **Dress properly. Do not wear loose clothing or jewellery. Keep your hair, clothing, and gloves away from moving parts.** *Loose clothes, jewellery or long hair can be caught in moving parts.*
 - g) **If devices are provided for the connection of dust extraction and collection facilities, ensure these are connected and properly used.** *Use of dust collection can reduce dust-related hazards.*
- ### 4) Power Tool Use and Care
- a) **Do not force the power tool. Use the correct power tool for your application.** *The correct power tool will do the job better and safer at the rate for which it was designed.*
 - b) **Do not use the power tool if the switch does not turn it on and off.** *Any power tool that cannot be controlled with the switch is dangerous and must be repaired.*
 - c) **Disconnect the plug from the power source and/ or the battery pack from the power tool before making any adjustments, changing accessories, or storing power tools.** *Such preventive safety measures reduce the risk of starting the power tool accidentally.*
 - d) **Store idle power tools out of the reach of children and do not allow persons unfamiliar with the power tool or these instructions to operate the power tool.** *Power tools are dangerous in the hands of untrained users.*
 - e) **Maintain power tools. Check for misalignment or binding of moving parts, breakage of parts and any other condition that may affect the power tool's operation. If damaged, have the power tool repaired before use.** *Many accidents are caused by poorly maintained power tools.*
 - f) **Keep cutting tools sharp and clean.** *Properly maintained cutting tools with sharp cutting edges are less likely to bind and are easier to control.*
 - g) **Use the power tool, accessories and tool bits**

etc. in accordance with these instructions, taking into account the working conditions and the work to be performed. Use of the power tool for operations different from those intended could result in a hazardous situation.

5) Battery Tool Use and Care

- a) **Recharge only with the charger specified by the manufacturer.** A charger that is suitable for one type of battery pack may create a risk of fire when used with another battery pack.
- b) **Use power tools only with specifically designated batteries.** Use of any other batteries may create a risk of injury and fire.
- c) **When battery is not in use, keep it away from other metal objects like: paper clips, coins, keys, nails, screws, or other small metal objects that can make a connection from one terminal to another.** Shorting the battery terminals together may cause sparks, burns, or a fire.
- d) **Under abusive conditions, liquid may be ejected from the battery; avoid contact.** If contact accidentally occurs, flush with water. If liquid contacts eyes, additionally seek medical help. *Liquid ejected from the battery may cause irritation or burns.*

6) Service

- a) **Have your power tool serviced by a qualified repair person using only identical replacement parts.** This will ensure that the safety of the power tool is maintained.

Safety instructions for all operations

Safety Warnings Common for Grinding operations

- a) **This power tool is intended to function as a grinder. Read all safety warnings, instructions, illustrations and specifications provided with this power tool.** Failure to follow all instructions listed below may result in electric shock, fire and/or serious injury.
- b) **Operations such as sanding, wire brushing, polishing are not recommended to be performed with this power tool.** Operations for which the power tool was not designed may create a hazard and cause personal injury.
- c) **Do not use accessories which are not specifically designed and recommended by the tool manufacturer.** Just because the accessory can be attached to your power tool, it does not assure safe operation.
- d) **The rated speed of the accessory must be at least equal to the maximum speed marked on the power tool.** Accessories running faster than their rated speed can break and fly apart.
- e) **The outside diameter and the thickness of your accessory must be within the capacity rating of your power tool.** Incorrectly sized accessories

cannot be adequately guarded or controlled.

- f) **Threaded mounting of accessories must match the grinder spindle thread. For accessories mounted by flanges, the arbour hole of the accessory must fit the locating diameter of the flange.** Accessories that do not match the mounting hardware of the power tool will run out of balance, vibrate excessively and may cause loss of control.
- g) **Do not use a damaged accessory. Before each use inspect the accessory such as abrasive wheels for chips and cracks, backing pad for cracks, tear or excess wear, wire brush for loose or cracked wires.** If power tool or accessory is dropped, inspect for damage or install an undamaged accessory. After inspecting and installing an accessory, position yourself and bystanders away from the plane of the rotating accessory and run the power tool at maximum no-load speed for one minute. *Damaged accessories will normally break apart during this test time.*
- h) **Wear personal protective equipment.** Depending on application, use face shield, safety goggles or safety glasses. As appropriate, wear dust mask, hearing protectors, gloves and workshop apron capable of stopping small abrasive or work piece fragments. *The eye protection must be capable of stopping flying debris generated by various operations. The dust mask or respirator must be capable of filtering particles generated by your operation. Prolonged exposure to high intensity noise may cause hearing loss.*
- i) **Keep bystanders a safe distance away from work area.** Anyone entering the work area must wear personal protective equipment. *Fragments of workpiece or of a broken accessory may fly away and cause injury beyond immediate area of operation.*
- j) **Hold the power tool by insulated gripping surfaces only, when performing an operation where the cutting accessory may contact hidden wiring.** Cutting accessory contacting a "live" wire may make exposed metal parts of the power tool "live" and could give the operator an electric shock.
- K) **Never lay the power tool down until the accessory has come to a complete stop.** The spinning accessory may grab the surface and pull the power tool out of your control.
- l) **Do not run the power tool while carrying it at your side.** Accidental contact with the spinning accessory could snag your clothing, pulling the accessory into your body.
- m) **Regularly clean the power tool's air vents.** The motor's fan will draw the dust inside the housing and excessive accumulation of powdered metal may cause electrical hazards.
- n) **Do not operate the power tool near flammable materials.** Sparks could ignite these materials.

- o) **Do not use accessories that require liquid coolants.** *Using water or other liquid coolants may result in electrocution or shock.*

Further safety instructions for all operations Kickback and Related Warnings

Kickback is a sudden reaction to a pinched or snagged rotating wheel, backing pad, brush or any other accessory. Pinching or snagging causes rapid stalling of the rotating accessory which in turn causes the uncontrolled power tool to be forced in the direction opposite of the accessory's rotation at the point of the binding.

For example, if an abrasive wheel is snagged or pinched by the workpiece, the edge of the wheel that is entering into the pinch point can dig into the surface of the material causing the wheel to climb out or kick out. The wheel may either jump toward or away from the operator, depending on direction of the wheel's movement at the point of pinching. Abrasive wheels may also break under these conditions.

Kickback is the result of power tool misuse and/or incorrect operating procedures or conditions and can be avoided by taking proper precautions as given below.

- a) **Maintain a firm grip on the power tool and position your body and arm to allow you to resist kickback forces. Always use auxiliary handle, if provided, for maximum control over kickback or torque reaction during start-up.** *The operator can control torque reactions or kickback forces, if proper precautions are taken.*
- b) **Never place your hand near the rotating accessory.** *Accessory may kickback you're your hand.*
- c) **Do not position your body in the area where power tool will move if kickback occurs.** *Kickback will propel the tool in direction opposite to the wheel's movement at the point of snagging.*
- d) **Use special care when working corners, sharp edges etc. Avoid bouncing and snagging the accessory.** *Corners, sharp edges or bouncing have a tendency to snag the rotating accessory and cause loss of control or kickback.*
- e) **Do not attach a saw chain woodcarving blade or toothed saw blade.** *Such blades create frequent kickback and loss of control.*

Additional safety instructions for grinding operations

Safety Warnings Specific for Grinding Operations:

- a) **Use only wheel types that are recommended for your power tool and the specific guard designed for the selected wheel.** *Wheels for which the power tool was not designed cannot be adequately guarded and are unsafe.*
- b) **The grinding surface of centre depressed wheels must be mounted below the plane of**

the guard lip. *An improperly mounted wheel that projects through the plane of the guard lip cannot be adequately protected.*

- c) **The guard must be securely attached to the power tool and positioned for maximum safety, so the least amount of wheel is exposed towards the operator.** *The guard helps to protect the operator from broken wheel fragments, accidental contact with wheel and sparks that could ignite clothing.*
- d) **Wheels must be used only for recommended applications. For example: do not grind with the side of cut-off wheel.** *Abrasive cut-off wheels are intended for peripheral grinding, side forces applied to these wheels may cause them to shatter.*
- e) **Always use undamaged wheel flanges that are of correct size and shape for your selected wheel.** *Proper wheel flanges support the wheel thus reducing the possibility of wheel breakage. Flanges for cut-off wheels may be different from grinding wheel flanges.*
- f) **Do not use worn down wheels from larger power tools.** *Wheel intended for larger power tool is not suitable for the higher speed of a smaller tool and may burst.*

Battery safety warning

- a) Do not dismantle, open or shred secondary cells or batteries.
- b) Keep batteries out of the reach of children
Battery usage by children should be supervised. Especially keep small batteries out of reach of small children.
- c) Do not expose cells or batteries to heat or fire. Avoid storage in direct sunlight.
- d) Do not short-circuit a cell or a battery. Do not store cells or batteries haphazardly in a box or drawer where they may short-circuit each other or be short-circuited by other metal objects.
- e) Do not subject cells or batteries to mechanical shock.
- f) In the event of a cell leaking, do not allow the liquid to come in contact with the skin or eyes. If contact has been made, wash the affected area with copious amounts of water and seek medical advice.
- g) Do not use any charger other than that specifically provided for use with the equipment.
- h) Do not use any cell or battery which is not designed for use with the equipment.
- i) Do not mix cells of different manufacture, capacity, size or type within a device.
- j) Always purchase the battery recommended by the device manufacturer for the equipment.
- k) Keep cells and batteries clean and dry.
- l) Wipe the cell or battery terminals with a clean dry cloth if they become dirty.
- m) Secondary cells and batteries need to be charged

before use. Always use the correct charger and refer to the manufacturer's instructions or equipment manual for proper charging instructions.

- n) Do not leave a battery on prolonged charge when not in use.
- o) After extended periods of storage, it may be necessary to charge and discharge the cells or batteries several times to obtain maximum performance.
- p) Retain the original product literature for future reference.
- q) Use the cell or battery only in the application for which it was intended.
- r) When possible, remove the battery from the equipment when not in use.
- s) Keep the cell or battery away from microwaves and high pressure.
- t) Dispose of properly.

VOLTAGE WARNING:

Before connecting the machine to a power source (receptacle, outlet, etc.), be sure the voltage supplied is the same as that specified on the nameplate of the machine. A power source with voltage greater than that specified for the machine can result in **SERIOUS INJURY** to the user, as well as damage to the machine. If in doubt, **DO NOT PLUG IN THE MACHINE**. Using a power source with voltage less than nameplate rating is harmful to the motor.

SAVE THESE INSTRUCTIONS.

WARNING! MISUSE or failure to follow the safety rules stated in this instruction manual may cause serious personal injury.

Symbol

-  **WARNING**
-  To reduce the risk of injury, user must read instruction manual
-  Always wear eye protection
-  Always operate with two hands
-  Do not burn
-  Do not charge a damaged battery pack
-   Do not dispose of batteries. Return exhausted batteries to your local collection or recycling point.
- Li-Ion

Technical data

| | |
|---|------------|
| Model | GC2038 |
| Rated Voltage(V ) | 20 |
| Wheel Size(mm) | Ø125x4xØ22 |
| Rated Speed (/min) | 8500 |
| Spindle Thread | M14 |
| Net Weight (whitout battery) kg | 1.6 |

※Due to the continuing program of research and development, the specifications herein are subject to change without prior notice.

※Illustrations, figures and photos may vary slightly due to program of continuous product improvements, please in kind prevail.

GENERAL DESCRIPTIONS

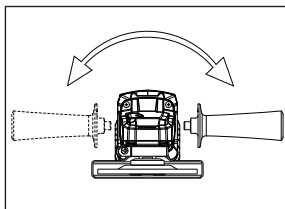
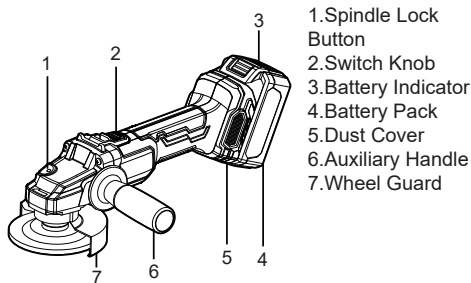

CAUTION: Be sure to firmly install the auxiliary handle before operation.

INSTRUCTIONS FOR OPERATION

CAUTION: Before any work on the machine itself (e.g. maintenance, tool change, etc.) as well as during transport and storage, remove the battery from the power tool.

Installing or Removing Wheel Guard

CAUTION: To use the tool with wheel guard only. Keep body in the closed side of the wheel guard. Mount the wheel guard with the protrusion on the wheel guard band aligned with the notch on the bearing box. Then rotate the wheel guard to the desired position and fix the hex socket head screw with a wrench.

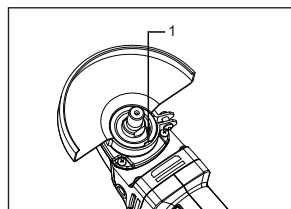

1.protrusion and notch

To remove wheel guard, follow the installation.

Installing or Removing the Depressed Center Wheel

Screw the inner flange onto the spindle. Press the spindle lock firmly so that the spindle cannot revolve. Then use the lock nut wrench to secure the inner flange. Fit the wheel on over the inner flange and screw the outer flange onto the spindle.

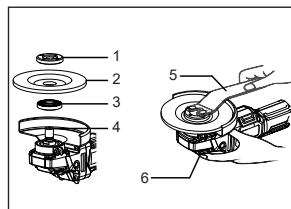

1.outer flange
2.wheel
3.inner flange
4.spindle
5.wrench
6.spindle lock

• Spindle Lock

CAUTION: Never actuate the spindle when the spindle is moving. The tool may be damaged. Press the spindle lock to prevent spindle rotation when installing or removing the wheel.

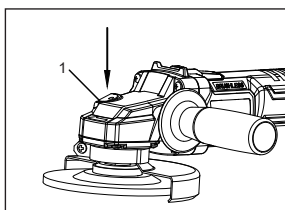

1.Spindle Lock

• Switch Operation

WARNING! Before plugging in the tool, always check to see that the switch actuates properly and returns to the "OFF" position when the rear of the switch knob is depressed. Push the switch knob forward and press it downward, the knob can be locked on the "I (ON)" position and when released, it can rebound to "O (OFF)" position automatically. To start the tool, push the switch knob to "I (ON)" position and lock it; to stop the tool, release the knob and rebounds to "O (OFF)" position.

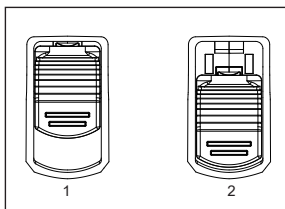

1.I (ON)
2.O (OFF)

• Switch ON and OFF of Machine

To switch ON, push the switch knob forward in the direction of arrow ①. Then depress the front of the switch knob in the direction of arrow ② to lock it.

• Mounting the Auxiliary Handle

Screw the auxiliary handle on the right or left of the tool head.

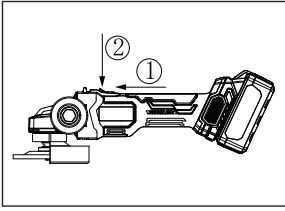

To switch OFF, depress the rear of the switch knob to unlock the switch and the knob will return to the OFF position normally.

● **Installing or Removing the Battery**

CAUTION: Do not force the battery pack out.

1. Installing the Battery

To install the battery firmly, insert it properly all the way until it locks in place with a little click. If not, it may accidentally fall out of the tool, causing injury to you or someone around you. Avoid overexerting or hammering the battery into the motor housing with the help of other objects.

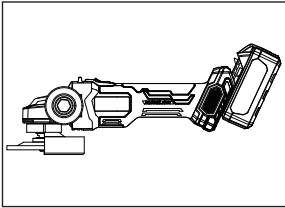

2. Removing the Battery

The battery pack is equipped under the machine handle, press the unlock button, and then pull out the battery.

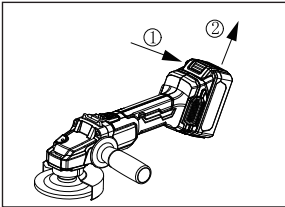

● **Grinding Operation**

CAUTION: Always wear protective devices like gloves, glasses, etc.

Switch on the tool and hold it firmly with one hand gripping the tool body and the other hand holding the auxiliary handle. Then apply the wheel or disc to the workpiece.

In general, keep the edge of the wheel or disc at an angle of about 15°-30° to the workpiece surface. During the break-in period with a new wheel, do not work the grinder in the B direction, or it will cut into the workpiece. Once the edge of the wheel has been

rounded off by use, the wheel may be worked in both A and B directions.

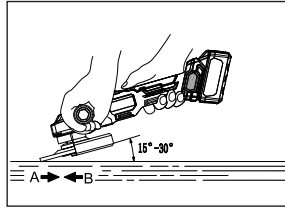

● **Cutting Operation**

Switch on the tool and hold it firmly with one hand gripping the tool body and the other hand holding the auxiliary handle. Then apply the wheel or disc to the workpiece. Keep the edge of the wheel or disc at an angle of about 90° to the workpiece surface.

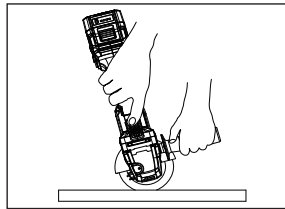

● **Battery Indicator**

CAUTION:

Current power of the battery will be indicated by the battery indicator when pressing the battery button or switching on the tool.

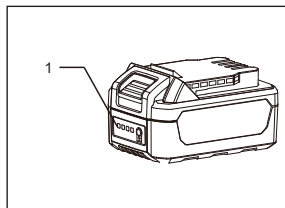

1. power indicated light

Four red LED lights are set to indicate the battery power which can be referred to the following table.

| Status of Red LED Lights | Approx. Battery Power Left |
|--------------------------|----------------------------|
| 4 lights lit | 75%~100% |
| 3 lights lit | 50%~75% |
| 2 lights lit | 25%~50% |
| 1 light lit | 10%~25% |

● **Battery Charging Charging Operation**

The battery charger can detect some sort of failure caused by the battery and indicates by the statuses

of the red and green indicator lights. When a failure occurs, remove the battery and then insert it into the charger again. If the failure continues, change with a new battery. If the new battery can be charged, then the old battery maybe damaged. If the charging indicator lights indicate same failure as before while changing with a new battery, then the charger maybe damaged, take the charger to be repaired by qualified serviceman.

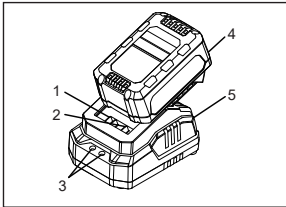

1. negative pole
2. positive pole
3. indicator light
4. battery pack
5. charger

Continuous Use

If the tool is operated continuously until the battery cartridge has discharged, allow the tool to rest for 15minutes before proceeding with a fresh battery.

MAINTENANCE

CAUTION: Always be sure that the tool is switched off and unplugged before attempting to perform inspection or maintenance.

Cleaning air vents

Always keep air intake and outtake clean. Clean them regularly or if they are jammed.

Inspecting the mounting screws

Regularly inspect all mounting screws and ensure that they are properly tightened. Should any of the screws be loose, retighten them immediately. Failure to do so could result in serious hazard.

Cleaning

Clean dust and debris from vents. Keep the machine handles clean, dry and free of oil or grease)

● Cleaning dustproof net

Pry the dustproof net out from the two places in with a flat blade screwdriver and clean the net to allow the air to circulate.

Clean up the dustproof net when it is clogged with dirt and foreign matters to protect damage from the machine.

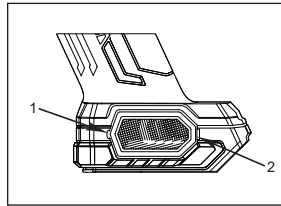

※ To maintain product SAFETY and RELIABILITY, repairs, any other maintenance or adjustment should be performed by authorized centers, always using original replacement parts.

For battery tools:

Ambient temperature range during operation and storage: 0°C - 45°C .

Recommended ambient temperature range during charging: 5°C - 40°C .

| | Charger | Battery Pack |
|-------|---------|--------------|
| Model | GC1000 | GC1040 |
| | GC1001 | GC1050 |

EXPLANATION OF GENERAL VIEW

| | | | |
|----|--|----|--|
| 1 | Outer Flange | 23 | Cross Recessed Pan Head Screw M4×12 (With Spring Washers) |
| 2 | Inner Flange | 24 | Fan Cover |
| 3 | Wheel Guard Assembly | 25 | Baffle Plate |
| 4 | Drive Spindle | 26 | Washer (8×12×1) |
| 6 | Dust Cap | 27 | Armature |
| 7 | Gear Housing Cover | 28 | Bearing625P-2RS |
| 8 | O Ring (47.5×2) | 29 | Stator Assembly |
| 9 | Dustproof Washer | 30 | Cross Recess Cross Recessed Pan Head Tapping Screw ST2.2×6 |
| 10 | Bearing6201V-VV | 31 | 20V Brushless Angle Grinder Pcb Assembly |
| 11 | Circlip For Hole32 | 32 | Right Motor Housing |
| 12 | Driven Spiral Bevel Gear | 33 | Nameplate |
| 13 | Needle Bearing HK0709 | 34 | Cross Recessed Pan Head Tapping Screw ST3.5×20 |
| 14 | Cross Recessed Pan Head Tapping Screw ST4×27 | 35 | Dust Cap |
| 15 | Gear Housing | 36 | Switch Knob |
| 16 | Lock Pin | 37 | Pull Rod |
| 17 | Autolocking Spring (8.7×0.8×11) | 38 | Pivot Pin |
| 18 | Lock Nut | 39 | Dwang |
| 19 | Hexagonal Nut M5 (Non-Standard) | 40 | Switch |
| 20 | Driving Spiral Bevel Gear | 41 | Buttery Combonation Hub |
| 21 | Bearing608Np-2RS | 42 | 18V Brushless Pcb Wire |
| 22 | Bearing Retainer | 43 | Left Motor Housing |

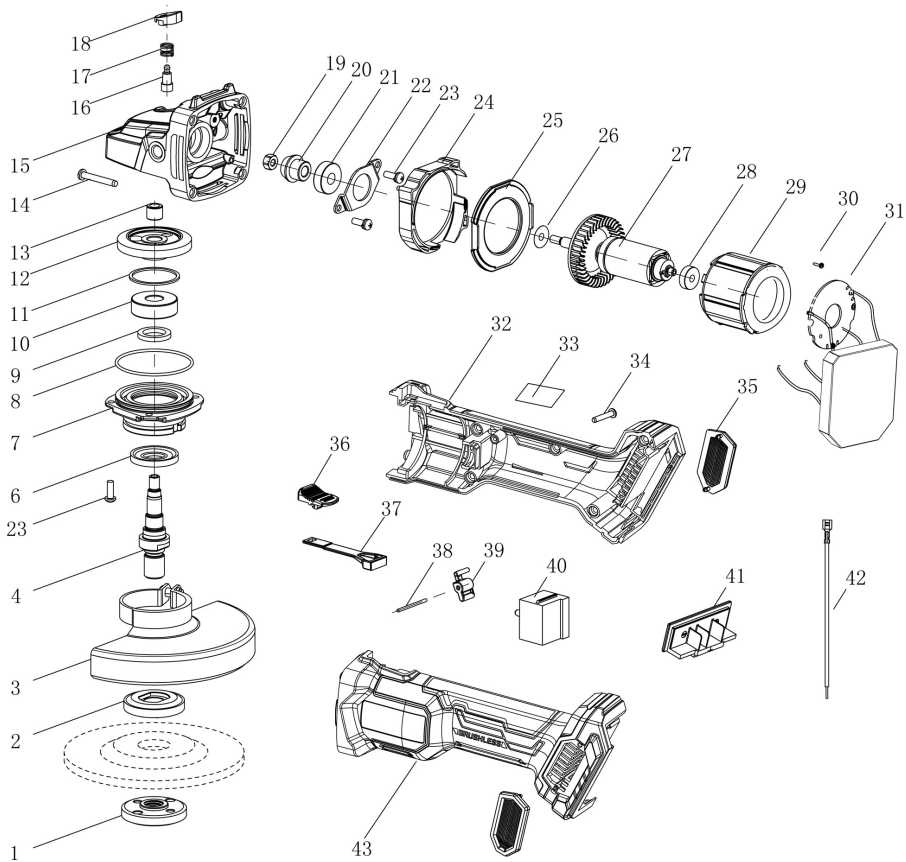

INNOVATION
PERFORMANCE
SAFETY
CONFIDENCE
GAZELLE

GAZELLE

sales@gazelleindustrial.com | www.gazelleindustrial.com